

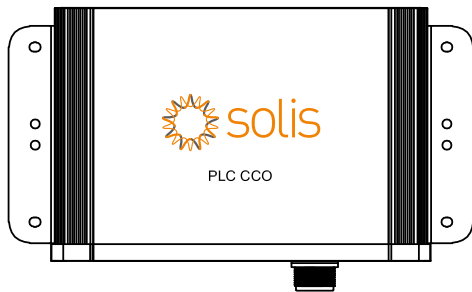

# Quick Installation Manual v1.2

## PLC CCO



### 1 Introduction

Solis PLC CCO is applied in PV systems to achieve power line communication. Power Line Communication is transmission of data over the AC Wires of the system.

### 2 Package List

Package list is shown below:

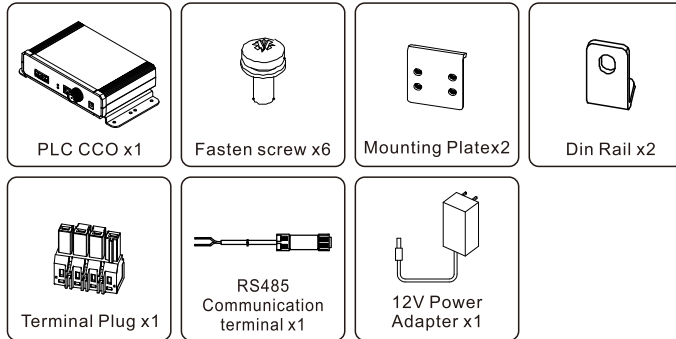

### 3 Warning

1. Disconnect any electrical connection and verify no live voltage before installation to prevent potential electrical hazard.
2. Verify Inverter AC Switch is in the "OFF" position.
3. Verify equipment has adequate ventilation to ensure system performance.
4. Ensure area of operation has no strong electromagnetic sources nearby.
5. Please ensure there is no heat source nearby.
6. Before doing any maintenance work, please ensure the power is off.
7. The PLC communication does not exceed 1000 meters on the overhead AC cable, No more than 500 meters on the ground AC cable.
8. PLCs from multiple manufacturers cannot be used in the same PV subarray, if you need to use it, please contact the manufacturer's technical staff in advance.
9. The PLC CCO should be connected as close to the AC side of the inverter as possible to reduce the number of circuit breakers passing by the PLC.

**Note:**

All operations must be conducted by professional electrical technicians.

### 4 Din-Rail Installation

1. Use the 4 M4 x 10 cross screws to fix unit to the wall.
2. Torque value = 1.2Nm

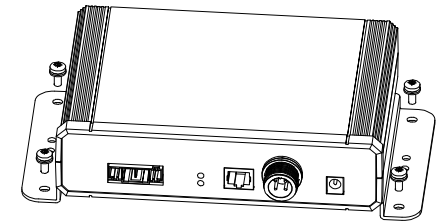

### 5 Ear-Wall Installation

1. Fix the PLC CCO with 4 M4\*10 screws onto the mounting plate with torque 1.2Nm.

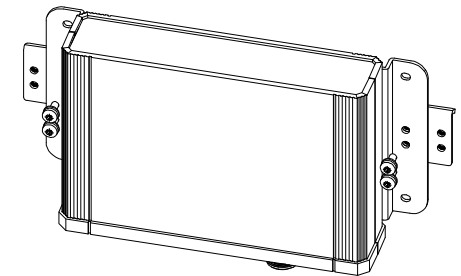

2. Clip the PLC CCO into the guide rail as shown below.

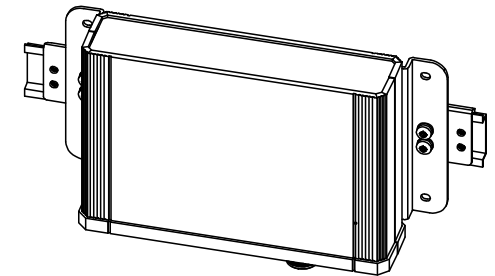

1. Use two M4 x 10 screws to fasten the PLC to guide rail.
2. Torque value = 1.2Nm

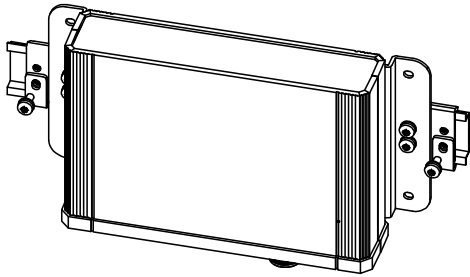

## 6 Cable Connection

1. Strip off the insulation as shown below.

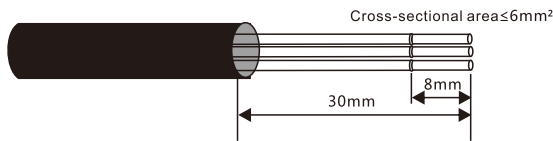

2. Use a slot type screwdriver to press the position in red and insert the A, B, C, N to Pin 1,2,3,4. Neutral is not necessary.

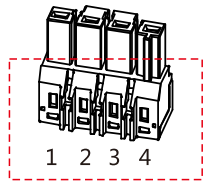

3. Connect the terminal to PLC CCO as shown below.

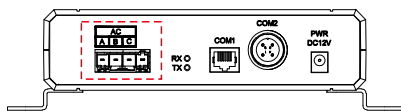

4. Connect RS485 communication cable to COM1(RJ45) or COM2(4 core connector)

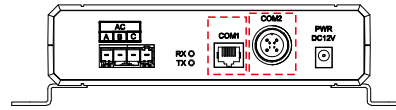

5. Connect 12V power line to PWR DC 12V port on the PLC CCO device.

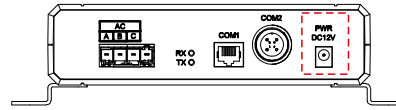

## 7 Finish Installation

Dear users, you have completed the whole installation process.

### Note:

This PLC device has two installation methods, Ear-Wall Hanging and Din-Rail installation methods, please select the suitable installation method according to the on-site situation.

## 8 Working Principle

Solis string inverters integrated with PLC communication module "PLC STA" can conduct PLC through AC power cables and communicate with the PLC CCO. The PLC CCO uses the isolation coupling circuit to isolate low-frequency AC power and protects the internal board. It conducts bi-directional PLC signaling and RS485 signal conversion to communicate with a corresponding datalogger. The diagram of PLC communication system is as follows:

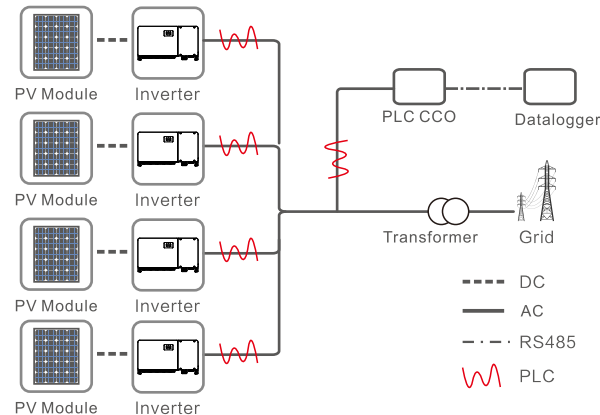

## 9 Characteristic

1. Adopt OFDM technology, subcarrier supports BPSK, QPSK, 8QAM, 16QAM, 64QAM modulation method.
2. Integrated with high performance ARM CPU, main frequency reaches 266MHz, satisfying smart grid requirements.
3. Support FEC and CRC function with strong capability of noise reduction and error recovering.
4. Support ad-hoc network and dynamic-route addressing function.

## 10 Technical specifications

Product name	PLC CCO
Input voltage of the power adapter	100V AC~240V AC, 50Hz/60Hz
Power consumption	< 5W
Input cable voltage of the AC port	380V AC~800V AC
Operating temperature	-25℃~+70℃
Relative humidity (non-condensing)	5%~95%
Altitude	0m~4000m
Protection level	IP20
Installation mode	Hanging installation or Din Rail installation
Maximum number of PLC STAs that can be connected	80pcs
Maximum transmission rate	115200bit/s
Dimensions (W x H x D)	180mm×120mm×45mm
Weight	485g
Certification	UL, FCC